

6-FM-40Ah

Valve-regulated Lead Acid Battery Specification

Features

- Maintenance free
- Safety and no leakage
- Excellent recharge and discharge performance
- Low self-discharge rate
- Adapt to high or low temperature
- Good deep discharge performance
- Longer cycle life



Specification

Rated Voltage	12V
Numbers of cells	6 Cells
Capacity	40Ah@10hr-rate to 1.80V per cell @25°C
Weight	13.2kg
Internal Resistance	Approx. 9.6 mΩ
Terminal	F6
Max. Discharge Current	600A(5s)
Short Circuit Current	1900A
Max. Charging Current	10A
Reference Capacity	C10 40.0AH C3 30.6AH C1 22.1AH
Design Life	10~15 years
Float Charging Voltage	13.6 V~13.8 V @ 25°C Temperature Compensation: -20mV/°C/Cell
Cycle Use Voltage	14.4 V~14.9 V @ 25°C Temperature Compensation: -30mV/°C/Cell
Operating Temperature Range	Discharge: -15°C~50°C Charge: 0°C~40°C Storage: -15°C~40°C
Normal Operating Temperature Range	25°C±5°C
Self Discharge	Less than 3% at 25°C per month
Container Material	A.B.S. UL94-HB, UL94-V0 Optional.

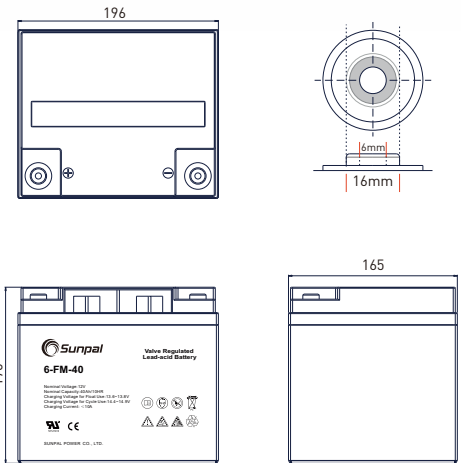

Length	196±2mm (7.7 inches)
Width	165±1mm (6.5 inches)
Height	170±1mm (6.7 inches)
Total Height	170±1mm (6.7 inches)

Constant Current Discharge Characteristics: A[25°C]

F.V/Time	5min	10min	15min	20min	30min	45min	1h	3h	5h	10h	20h
1.80V/cell	91.90	68.80	55.30	45.30	35.90	26.80	21.10	10.20	6.72	4.00	2.08
1.75V/cell	103.60	75.60	60.40	48.70	37.30	27.80	22.10	10.40	6.88	4.04	2.10
1.70V/cell	114.10	82.40	64.50	51.20	38.80	28.90	22.80	10.70	7.06	4.08	2.14
1.65V/cell	125.80	88.90	68.60	54.40	40.90	29.60	23.60	11.20	7.26	4.16	2.17
1.60V/cell	138.80	96.50	73.30	57.90	43.20	30.90	24.40	11.50	7.50	4.21	2.18

Constant Power Discharge Characteristics: WPC[25°C]

F.V/Time	5min	10min	15min	20min	30min	45min	1h	3h	5h	10h	20h
1.80V/cell	166.20	125.50	101.80	84.10	67.40	51.10	40.50	19.80	13.10	7.90	4.11
1.75V/cell	183.40	135.70	109.80	89.60	69.40	52.50	42.20	20.10	13.40	7.97	4.15
1.70V/cell	196.40	144.60	115.60	93.40	71.80	54.40	43.40	20.60	13.70	8.05	4.23
1.65V/cell	213.50	154.60	122.00	98.50	75.10	55.30	44.50	21.40	14.00	8.20	4.28
1.60V/cell	230.00	164.00	128.30	103.80	78.80	57.30	45.90	22.00	14.50	8.27	4.29

6-FM-40Ah

Valve-regulated Lead Acid Battery Specification

Charge Characteristics for Float Use @ 25°C/77°F

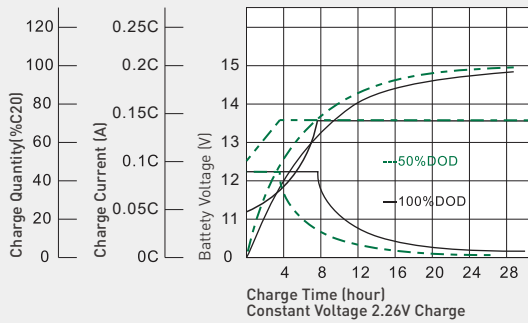

Discharge Characteristics at Various Rates @ 25°C/77°F

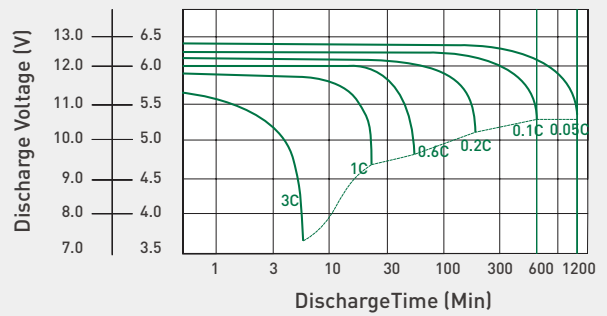

Cycle Life in Relation to Depth of Discharge

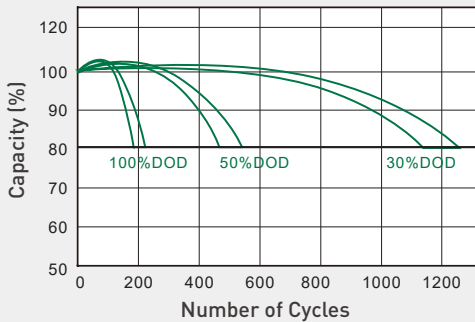

Float Service Life

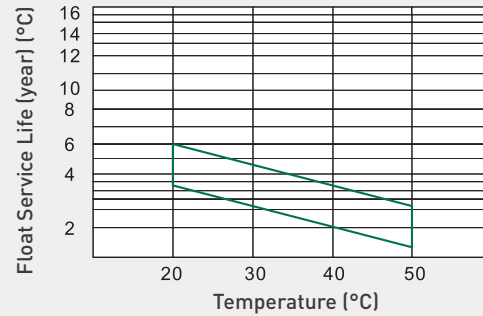

Temperature and Valid Capacity

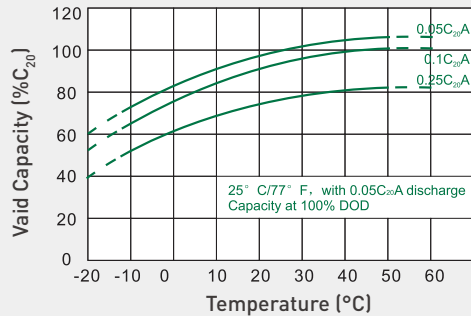

Self Discharge Characteristics

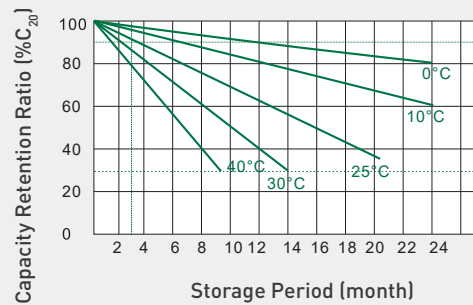

Capacity and Open Circuit Voltage

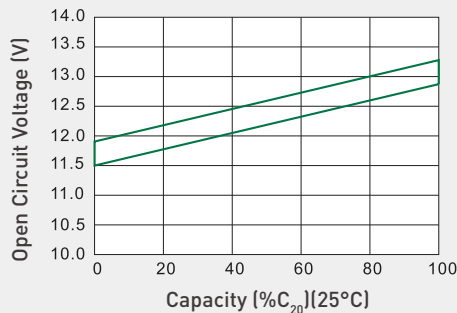

Relationship between Charging Voltage and Temperature

